

Direct Field-Oriented Control using Fuzzy Logic Type -2 for Induction Motor with Broken Rotor Bars

Belhamdi Saad *, Amar.Goléa **

*Electrical Engineering Lab., LGE, University of M'sila, M'Sila, Algeria

**LGEB Laboratories, Biskra University, Algeria

(bsaad1@yahoo.fr)

Abstract

In the paper an analysis of the Direct Field Control Fuzzy logic type-2 of induction motor drive with broken rotor bars is presented. The simplicity of traditional regulators makes them popular and the most used solution in the nowadays industry. However, they suffer from some limitations and cannot deal with nonlinear dynamics and system parameters variation. In the literature, several strategies of adaptation are developed to alleviate these limitations. Artificial intelligent has found high application in most nonlinear systems same as motors drive. Because it has intelligence like human but there are no sentimental against human like angriness and.... Artificial intelligent is used for various points like approximation, control, and monitoring. Because artificial intelligent techniques can use as controller for any system without requirement to system mathematical model, it has been used in electrical drive control. With this manner, efficiency and reliability of drives increase and volume, weight and cost of them decrease.

Keywords: Induction motor, Modeling, Direct Vector Control, Fuzzy logic type-2, broken bar

1. Introduction

Nowadays, there is a demand for high performance electric drives capable of accurately achieving speed command. This necessarily leads to more sophisticated control methods to deal with such an issue. A special attention was directed toward the induction motor because of known reasons such as: size, cost and efficiency. A high performance usually requires a good control system response regulation and prosecution, which is insensitive (otherwise insensitive) to changes in operating conditions and process parameters. In recent decades, several advanced control methods have been developed that are applicable to control induction motor. However, the control system performance with the induction motor has not been provided because of the

complexity of the control algorithms and highly non-linear characteristics of induction motor. The most widely used controller in the industrial an application is the PID-type controllers because of their simple structures and good performances in a wide range of operating conditions (Vinod Kumar , R. R. Joshi 2006 and Belhamdi, S, Goléa, A). The PID controllers are simple but cannot always effectively control systems with changing parameters or have a strong nonlinearity; and may need frequent on-line retuning. The conventional control design is based on a mathematical model that may often be unknown, ill-defined, nonlinear, complex and multivariable with parameter variation. As an intelligent control technology the FLC type-2 has the potential to accommodate an improved method of determining nonlinear models which are complementary to conventional techniques (H. Hagraas 2007 and Ashok Kusagur, 2009). The fuzzy algorithm is based on intuition and experience and can be regarded as a set of heuristic decision rules. The fuzzy algorithms have the common feature of not requiring a detailed mathematical model (H. Hagraas 2007 and Vinod Kumar, R. R. Joshi 2006). The FLC type-2 can give robust adaptive response to a drive with nonlinearity, parameter variations and load disturbance effects. The FLC type-2 provides a systematic method to incorporate human experience and applied nonlinear algorithms, characterized by a series of linguistic statements, into the controller. The FLC type-2 is gaining increasing emphasis in process control applications. The direct field oriented control of induction machine is presented in Section 2, the fuzzy logic technique for IM control is summarized in Section 3. Simulation results are reported in Section 4. Section 5 concludes the paper.

2. Modeling the induction motor for its control

The induction motor has the advantage of being robust, inexpensive and simple construction. This simplicity, however, comes great physical complexity related to electromagnetic interaction between the stator and the rotor . Moreover, to develop control approaches ensuring the hoped performance, we need a model that reflects the operation of the machine so that transient steady, and a model to account for failures rotor (broken bars) (Belhamdi, S, Goléa, A 2013 and Ashok Kusagur, 2009).

The electromagnetic torque is found as:

$$C_e = \frac{3}{2} p \cdot (\Phi_{ds} \cdot I_{qs} - \Phi_{qs} \cdot I_{ds}) \tag{1}$$

Flows in the reference frame of Park are given by the relations (Belhamdi, S, Goléa, A 2013):

$$\begin{cases} \Phi_{ds} = L_{sc} \cdot I_{ds} + M \cdot I_{dr} \\ \Phi_{qr} = L_{sc} \cdot I_{qs} + M \cdot I_{qr} \\ \Phi_{dr} = M \cdot I_{ds} + L_{rc} \cdot I_{dr} \\ \Phi_{qr} = M \cdot I_{qs} + L_{rc} \cdot I_{qr} \end{cases} \quad (2)$$

The equations tension of the machine is written to the system related to the rotating field configuration as follows:

$$\begin{cases} V_{ds} = R_s \cdot I_{ds} + \frac{d\Phi_{ds}}{dt} - \omega_s \Phi_{qs} \\ V_{qs} = R_s \cdot I_{qs} + \frac{d\Phi_{qs}}{dt} + \omega_s \Phi_{ds} \\ 0 = R_r \cdot I_{dr} + \frac{d\Phi_{dr}}{dt} - \omega_r \Phi_{qr} \\ 0 = R_r \cdot I_{qr} + \frac{d\Phi_{qr}}{dt} + \omega_r \Phi_{dr} \end{cases} \quad (3)$$

The main objective of the vector control of induction motors is, as in DC machines, to independently control the torque and the flux; this is done by using a d-q rotating reference frame synchronously with the rotor flux space vector . In ideally field-oriented control, the rotor flux linkage axis is forced to align with the d-axes, and it follows that (J. M. Mendel, R. I. B. John. 2002 and Vinod Kumar, R. R. Joshi 2006).

$$\begin{cases} \Phi_{dr} = \Phi_r = \text{constant} \\ \Phi_{qr} = 0 \end{cases} \quad (4)$$

Applying the result of (4) and (5), namely field-oriented control, the torque equation becomes analogous to the DC machine and can be described as follows:

$$C_e = \frac{3}{2} p \cdot \frac{M}{L_{rc}} \Phi_r I_{qs} \quad (5)$$

Consequently, the dynamic equations (3) yield:

$$\begin{aligned} V_{ds} &= (R_s + s \cdot \sigma \cdot L_{sc}) I_{ds} - \omega_s \cdot \sigma \cdot L_{sc} \cdot I_{qs} & \Phi_r &= \frac{M}{1 + s T_r} I_{ds} \\ V_{qs} &= (R_s + s \cdot \sigma \cdot L_{sc}) I_{qs} + \omega_s \frac{M}{L_{rc}} \Phi_r + \omega_s \sigma \cdot L_{sc} \cdot I_{ds} & \omega_r &= \frac{M}{T_r \Phi_r} I_{qs} \end{aligned} \quad (6)$$

3. Order by Fuzzy Logic-Type-2

Control by fuzzy logic is expanding. Indeed, this method provides an often very effective control law without doing extensive modeling. As opposed to a standard controller or a controller state against feedback, regulator fuzzy logic type-2 (RFLT2) does not address a well-defined mathematical relationship, but uses inferences with multiple rules, based on linguistic variables. By inferences with several rules, it is possible to take account of the experience acquired by the operators of a technical process. In this section, we present the general basics of fuzzy logic control and the general procedure for the design of a tuning fuzzy (Q. Liang, J. M. Mendel 2000 and J.M. Mendel 2006).

3.1. Design of Type-2 Fuzzy logic Mode Control

Type-1 and type-2 fuzzy logic are mainly similar. However, there exist two essential differences between them which are: the membership functions shape and the output processor. Indeed, an interval type-2 fuzzy controller is consisting of: a fuzzifier, an inference engine, a rules base, a type reduction and a defuzzifier (J. M. Mendel, R. I. B. John 2002 and Castillo, O., P. Melin 2012).

Fuzzy logic type-2 system includes 4 components (Mendel, 2007 and Belhamdi, S, Goléa, A 2014):

- **Fuzzifier:** Translates inputs (real values) to fuzzy values.
- **Inference System:** Applies a fuzzy reasoning mechanism to obtain a fuzzy output.
- **Type Defuzzifier/Reducer:** The defuzzifier translates one output to precise values; the type reducer transforms a Type-2 Fuzzy Set into a Type-1 Fuzzy Set.
- **Knowledge Base:** Contains a set of fuzzy rules, and a membership functions set known as the database.

In this paper, we propose application of type-2 fuzzy logic to control the value of α parameter. We assume two input linguistic variables: population diversity ($PD \in [-0.02; 0.02]$) which is represented by type-2 fuzzy sets (presented in Figure 1a). In the proposed type-2 fuzzy logic system only one output linguistic variable exists. This output variable is the α ($\alpha \in [-10; 10]$). Each linguistic variable possesses five linguistic values: NB, N, Z, P, PB, correspond to Negative Big, Negative, Zero, Positive, Positive Big respectively (Belhamdi, S, Goléa, A 2014).

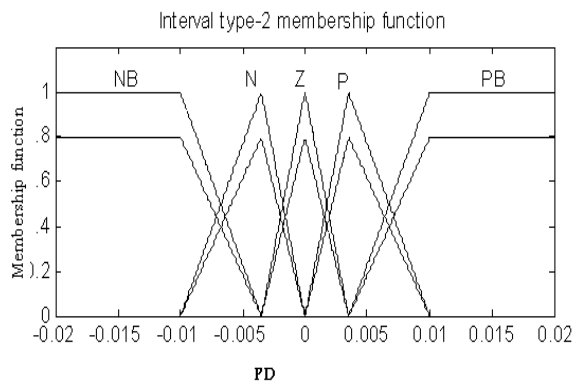

a: the input linguistic value

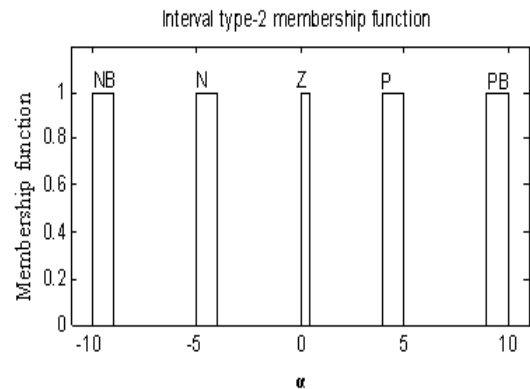

b: the output linguistic value

Figure1: Graphical representation of fuzzy sets which represent

A relation between input linguistic variables and output linguistic variable is determined by 25 fuzzy rules. (Belhamdi, S, Goléa, A 2014).

Table1. Fuzzy rule for type-2 FLCS

		e				
		NB	N	Z	P	PB
De	NB	NB	NB	N	N	Z
	N	NB	N	N	Z	PB
	Z	N	N	Z	P	PB
	P	N	Z	P	P	PB
	PB	Z	P	P	PB	PB

In the direct rotor field-oriented vector-controlled induction motor drives (DRFOC) the fault symptoms can be observed as characteristic frequencies of stator current components, rotor flux magnitude, control voltages and decoupling signals. So the monitoring of these signals can be useful from the diagnostic point of view. In this paper an analysis of a DRFOC induction motor drive with a faulty rotor is presented with respect to direct rotor speed measurement as well as a speed sensorless operation. The rotor flux and speed are reconstructed by an estimator the complete scheme of direct vector control rotor flux oriented is the following using fuzzy logic type-2 (Belhamdi, S, Goléa, A 2014):

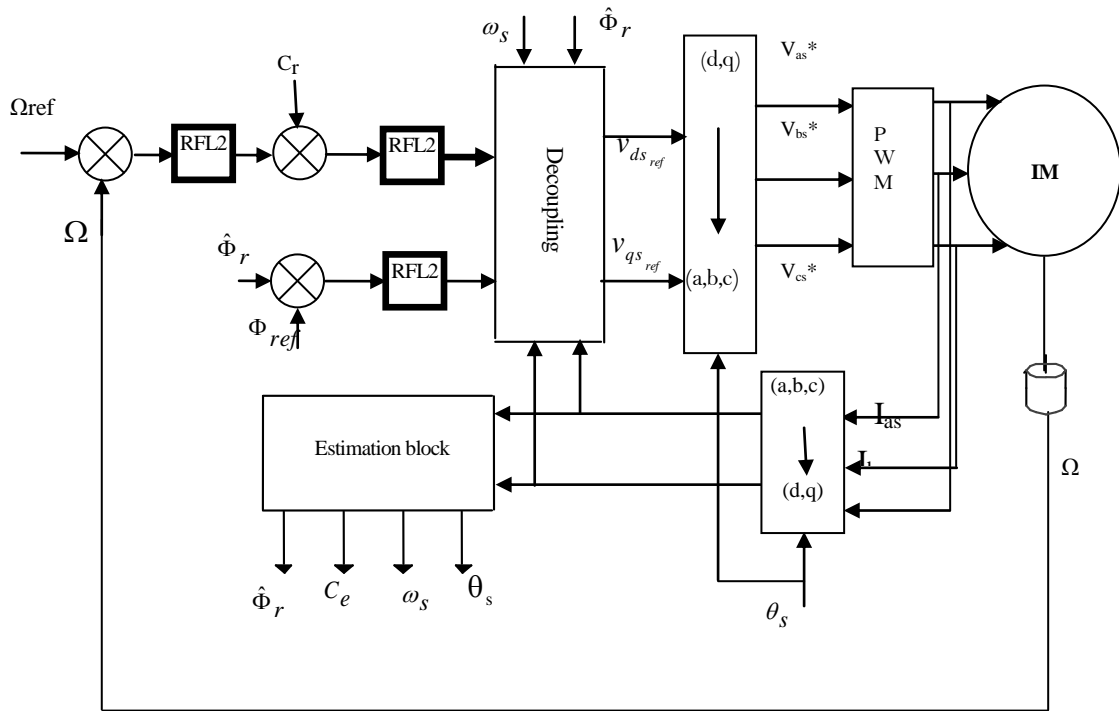

Figure 2: Speed control block by the direct method using regulator fuzzy type-2

4. Results and analysis

4.1. Healthy case

In order to analyze the drive system performance for speed and torque responses, with Healthy case, the above-presented system has been simulated using MATLAB/SIMULINK software. A squirrel cage induction motor with a rated power of 1.1 kW has been used. The specifications and parameters of the induction motor are listed in Appendix. The reference speed is 160 rad/sec. it is observed that motor pick up the reference speed at $t = 0.4$ sec Fig.3 shows the performance characteristic of motor, when a sudden change in reference speed from 160 to 100 rad/sec is made at $t = 1.5$ sec. This is due to the facts that the fuzzy control is a nonlinear control and the IM motor mathematical model is also non-linear and complex. The FL2 controller performed better performance with respect to rise time and steady state error.

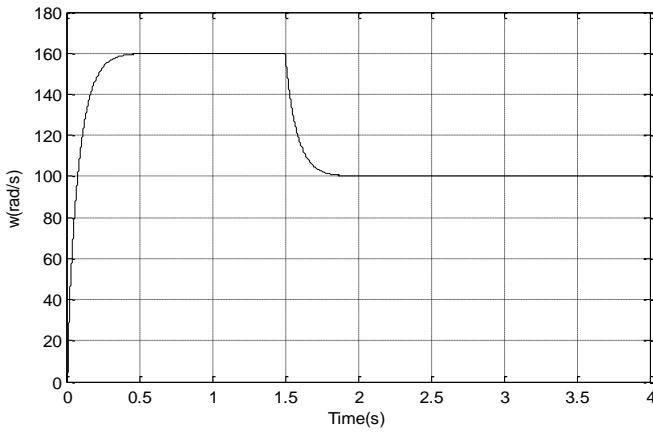

figure 3.a Speed response

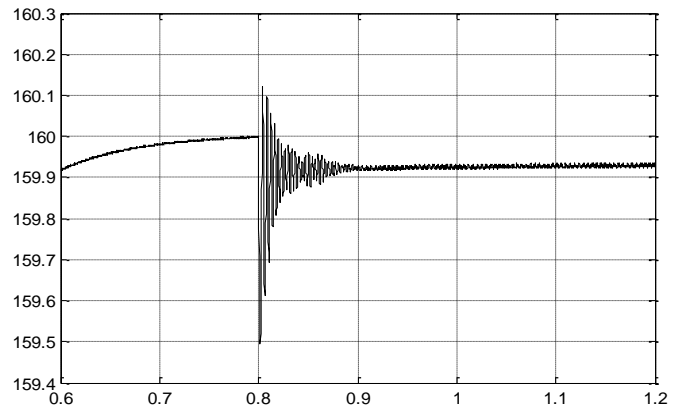

figure 3.b: Zoom of Speed

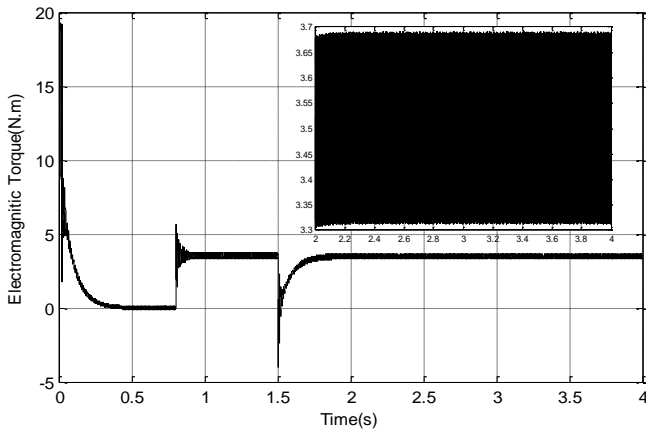

figure 3.c: Torque for healthy motor

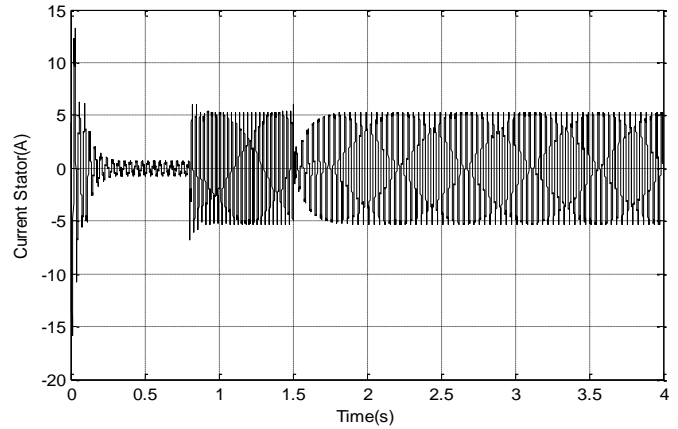

figure 3.d: The Stator current

Figure.3. Simulation results without Small-scale model

4.2. Case of two broken bars

Figure 4 shows the simulation of the testing machine, the squirrel-cage of the tested IM consists of 16 bars., A speed reference 160rad/s is imposed, a 3.5 Nm torque level is applied at $t = 0.8s$, at time $t = 1.5s$ Demine in speed at 100 rad/s, we perform a simulation of a first broken rotor bar at $t = 2.5s$ increasing resistance 11fois the resistance of the bar, the second adjacent broken rotor bar at $t = 3 s$. In bars break during we note that the speed remains constant insensitive broken the bars, demonstrating the robustness of the order by fuzzy logic type 2. There is a small fracture strain of the bar. In fact, it is on (Figure 4b) which cancels the loads instructions RLF2 effects perturbations applied at time $t = 0.8s$, so also we see in this figure that the electromagnetic torque following these instructions without causing overflows considered moments and with less

vibration. We also note the increase in the amplitude modulation of the stator current during the second broken rotor bar.

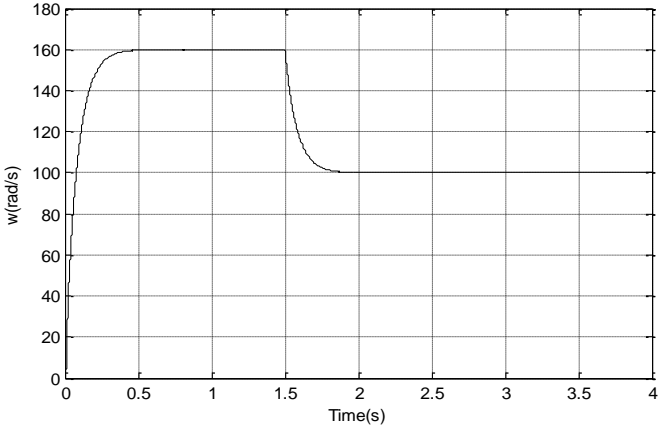

figure 4.a: Speed response

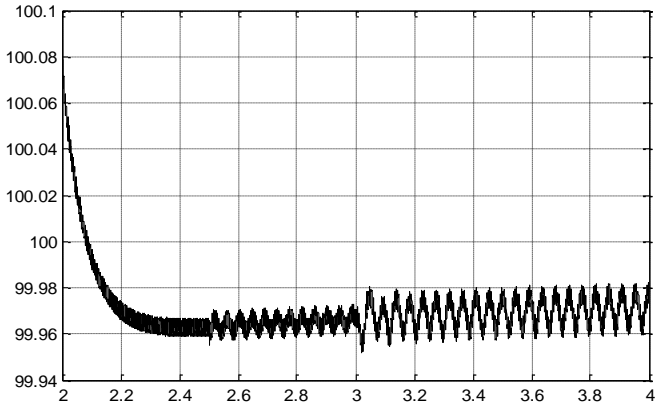

figure 4.b: Zoom of Speed

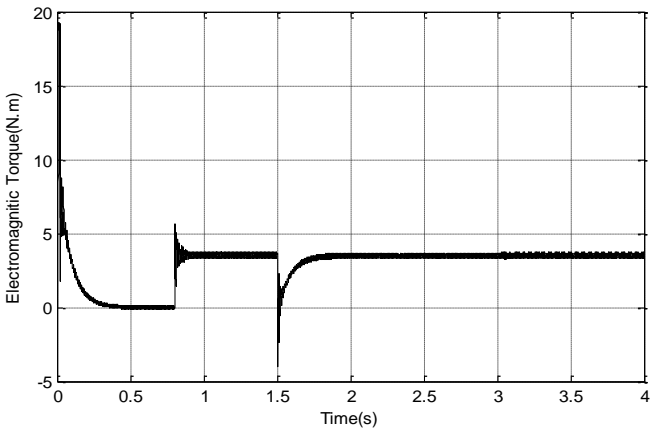

figure 4.c: Torque for healthy motor and broken rotor bars No 1 and 2

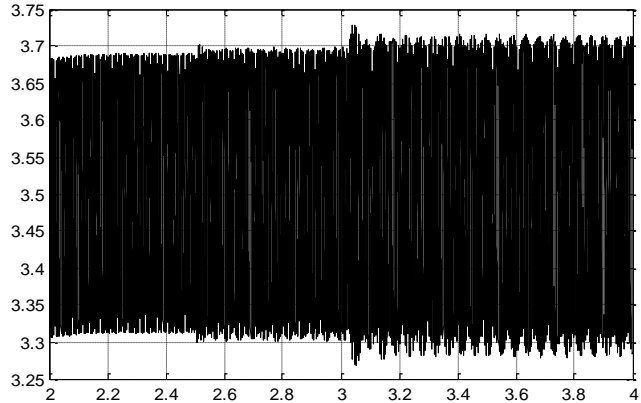

figure 4.d: Zoom of Torque

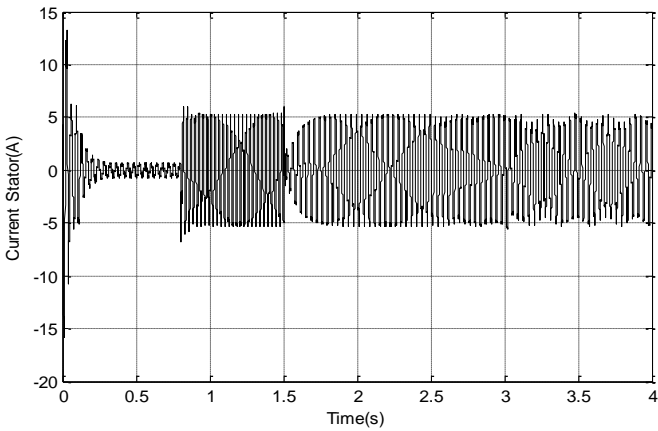

figure 4.e: The Stator current

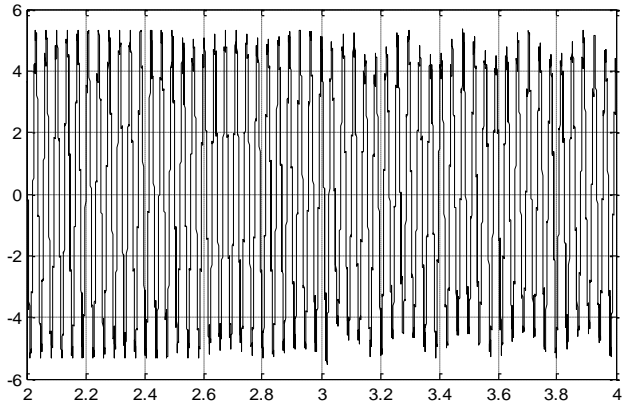

figure 4.f: Zoom of Stator current

Figure. 4. Simulation results without rotor defects

5. Conclusion

In this paper Fuzzy logic type-2 controller based DFOC system with faulted rotor has been proposed. A DFOC is successfully designed and it gives relatively better performance like reduced oscillations of the control variable compared to the conventional PI controller. Also, a fuzzy based fault detection scheme is proposed, where the parameters speed, torque and phase currents are derived from the analytical model for both normal and abnormal conditions. The simulation results have confirmed the efficiency of the Fuzzy logic type-2 controller for different working conditions. The results show that the Fuzzy logic type -2 controller has good performance, and it is robust against exterior perturbations.

• Appendix

The parameters of the machine used for simulation are listed below [7]:

$R_s=7.58(\Omega)$	Stator resistance
$R_r=6.3(\Omega)$	Rotor resistance
$J=0.0054(\text{Kgm}^2)$	Inertia
$N_s=160$	Number of turns per stator phase
$N_r=16$	Number of rotor bars
$R_b=0.00015(\Omega)$	Resistance of a rotor bar
$R_e=0.00015(\Omega)$	Resistance of end ring segment
$L_e=0.1e-6(\text{H})$	Leakage inductance of end ring
$L_b=0.1e-6\text{H}$	Rotor bar inductance
$p=2$	Poles number
$L=65(\text{mm})$	Length of the rotor
$E=25(\text{mm})$	Air-gap mean diameter
$L_{1s}=0.0265(\text{H})$	Mutual inductance
$P=1.1(\text{kW})$	Output power
$K_0=0(\text{SI})$	Friction coefficient
$220/380(\text{V})$	Stator voltage
$50(\text{Hz})$	Stator frequency

References

- 1 Q. Liang and J. M. Mendel, "Interval type-2 fuzzy logic systems: Theory and design", IEEE Trans. Fuzzy Syst, Vol 8, N05, pp535–550, 2000.

- 2 J.M. Mendel, R.I. John and F. Liu," Interval type-2fuzzy logic systems made simple", IEEE Transactions on Fuzzy Systems, Vol 14, N06, pp 808–821, 2006.
- 3 J. M. Mendel and R. I. B. John. "Type-2 fuzzy sets made simple", IEEE Transactions on Fuzz Systems, Vol 10, N02, pp 117–127,2002.
- 4 I. Takahashi and T. Noguchi," A New Quick Response and High-Efficiency Control Strategy of an Induction Motor",IEEE Trans. On IA, Vol 22, N05, pp 820-827, 1986.
- 5 H. Hagrais. Type-2 FLCs,"A new generation of fuzzy controllers", IEEE Computational Intelligence Magazine, Vol 2, pp 30-43, 2007.
- 6 Vinod Kumar, R. R. Joshi," Hybrid Controller based Intelligent Speed Control of Induction Motor", Journal of Theoretical and Applied Information Technology, Vol 3, N0 1, pp 71-75,2006.
- 7 Belhamdi, S, Goléa, A" Direct Torque Control for Induction Motor with broken bars Using Fuzzy Logic Type-2" AMSE Journals , Advances C ,Vol 70, no.1-2,pp.15-28, 2015.
- 8 Belhamdi, S, Goléa, A," Fuzzy logic Control of Asynchronous Machine Presenting Defective Rotor Bars", AMSE Journals, Advances C, Vol 68, N°2, pp 54-63,2013.
- 9 Castillo, O., P. Melin," A review on the design and optimization of interval type-2 fuzzy controllers" Applied Soft Computing, Vol 12, pp 1267–1278, 2012.
- 10 J.M.Mendel,R.I.John,andF.Liu, "Interval type-2fuzzy logic systems made simple",IEEE Transactions on Fuzzy Systems,vol. 14,No.6, pp.808–821,2006.
- 11 Ashok Kusagur, F.Kodad, BV, Sankar Ram," AI based design of a fuzzy logic scheme for speed control of induction motors using SVPWM technique",Proc, Int .Jr .Comp. Sci & Network Security, Vol 9, N01, pp74-80,2009.